



OLED Controller for WALRUS Heaters

Product Version: 210

Firmware Version: 6

Jacky Yang

September 24, 2024

Table of Contents

DESCRIPTION	1
CONTROLLER COMPONENTS.....	1
LED INDICATORS.....	1
INSTALLATION	2
<i>Caution:</i>	2
<i>Installation Steps:</i>	2
GETTING STARTED.....	4
MENU SELECTION	5
HEAT INTENSITY.....	5
COOLANT TEMPERATURE SETTING.....	5
DURATION SETTING.....	5
HEATER STATES.....	7
ON STATE	7
SHUTTING DOWN STATE.....	7
SHUTDOWN STATE	7
STANDBY STATE.....	7
SCHEDULING FUNCTION (TIMER).....	8
TURN ON/OFF TIMER.....	8
EDIT TIMER.....	8
SETTINGS	10
CURRENT TIME SETTING.....	10
LANGUAGE SETTING	10
BLUETOOTH SETTING	11
SOUND SETTING	11
HEATER INFORMATION	12
<i>ECU Software Version</i>	12
<i>Controller Software Version</i>	12
<i>Atmospheric Pressure & Ambient Temperature</i>	12
<i>Heater Run Time</i>	13
FUEL PRIMING FUNCTION.....	14
TROUBLESHOOTING	15

Description

This Controller is compatible with all WALRUS Plateau heaters.

Controller Components

1. OLED Display
2. LED Indicators
3. Knob
4. Settings Button
5. Back Button

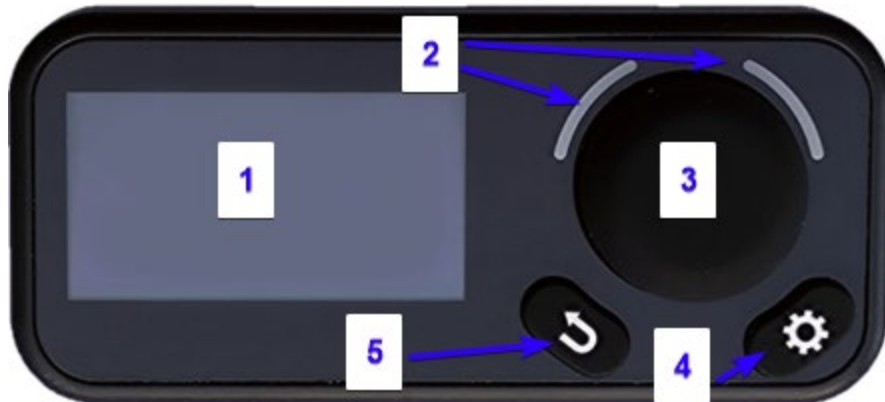

LED Indicators

Indicator Status	Status
Solid Blue	Initializing
Flashing Blue	Disconnected
Solid Green	ON
Solid Red	Shutting Down
No light	OFF
Flashing Green	Fault Detected

Installation

Caution:

- Controller must be installed in a dry and liquid free environment.
- Controller cable must not be shortened.
- Power must not be connected to the heater's wire harness when installing the Controller.

Installation Steps:

1. Clean the installation surface area to ensure that the surface is smooth and clean with no dust or water vapour.
2. Separate the back plate from the Controller.
3. Reserve a cutout for the Controller cable to go through the installation area.
4. Screw in the provided screws into the back plate as shown in Figure 1 below.
5. Connect the smaller end of the Controller cable to the terminal connector as shown in Figure 2 and pass through the other end of the cable through the reserved cutout in Step 3.
6. Assemble the Controller back together by pressing the Top Cover against the backplate as shown in Figure 3.

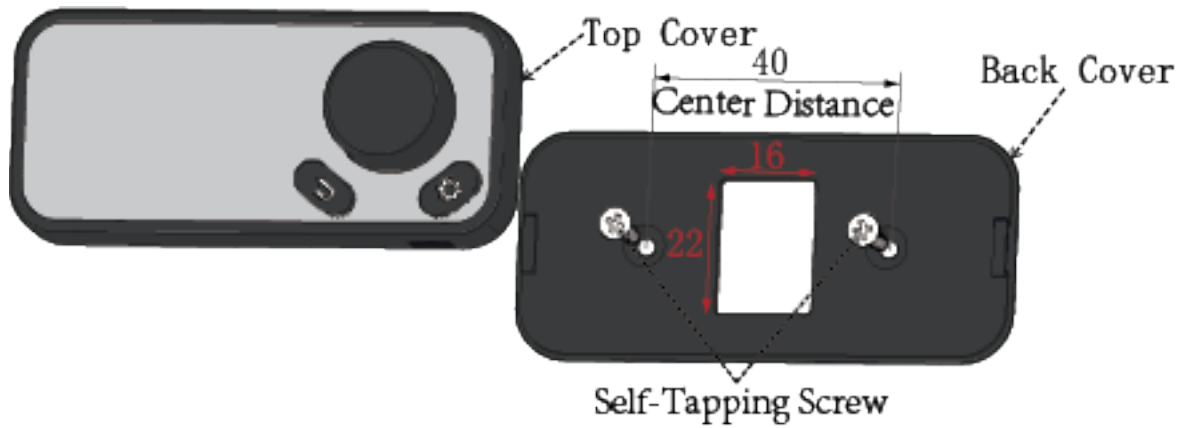

Figure 1
(The dimensions are in millimeters and are not to scale)

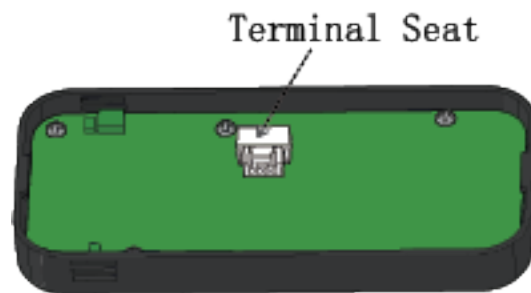

Figure 2

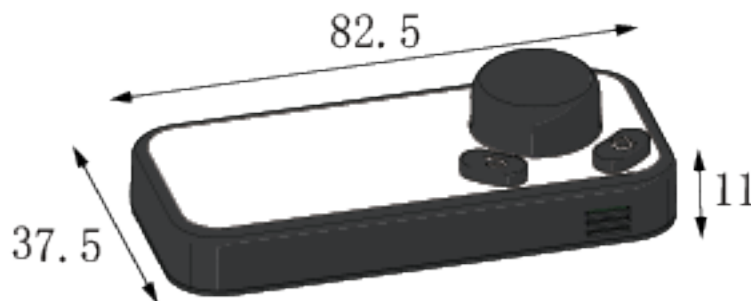

Figure 3

Getting Started

1. Connect power to the controller. Initializing screen will appear.



2. Display will go into the idle screen once initialization has finished.



3. If Initialization has failed, the controller will display No Connection.



4. Press and Hold the knob button for 2 seconds to turn on the heater.



5. Press and Hold the knob button for another 2 seconds to turn off the heater.



Menu Selection

With the heater in Idle mode, Press the knob button once to display the selection menu.

There are three menus:

- Heat Intensity (P1 – P6)
- Coolant Temperature Setting
- Duration Setting.

Turn the knob to select a different mode, Press the knob once to confirm your selection.

Heat Intensity



Press and hold the knob button for more than 2 seconds to turn on the heater.

Turn the knob clockwise to turn up the intensity level, counterclockwise to turn down the intensity level.

Coolant Temperature Setting

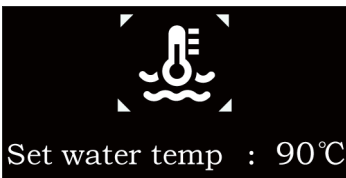

Once selected Coolant Temperature Setting, you will see the screen as shown to the left.

The coolant temperature can be set between 35°C and 95°C.

Turn the knob to change the coolant temperature setting.

Press the knob once to confirm your new temperature setting.

Duration Setting



Set the Duration to automatically turn off the heater.

The image to the left indicates the heater will run for 1 hour and 5 minutes.

Minimum Duration allowed is 10 minutes.



1. Highlight the Hour/Minute you'd like to modify.
2. Press the knob button once to select the hour/minute
3. Once you see up and down arrows on the hour/minute you've selected, rotate the knob to change values.

Note: Rotate the knob clockwise to go down the screen.



If Duration is set to INFINITY, the heater will not turn off automatically and will run indefinitely.

Heater States

ON State



The heater is on and in Operation.

In this example, the heater is ON and set to P4.

Shutting Down State



Heater is in its Shutdown phase (OFF is flashing).

Glow pin has been turned on to burn off any remaining fuel inside the combustion chamber to prevent carbon buildup.

****Note: DO NOT turn off the main power to the heater. Doing so may permanently damage the heater's ECU and blower motor.**

Shutdown State



The heater is in its OFF state. Fan and fuel pump should be inactive.

Standby State

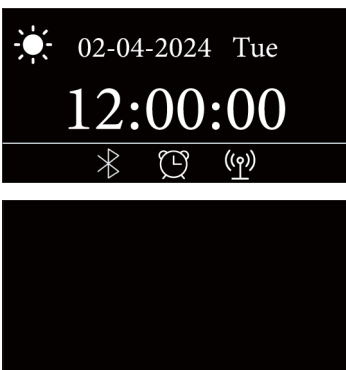

If no operation within 20 seconds, controller will display the current date and time. If standby mode is ON, the display will be turned off after another 20 seconds.

Standby mode is ON by default. To turn off Standby mode, press and hold the Settings button for 2 seconds.

Press the Back button or the knob button on the controller to exit out of Standby.

Scheduling Function (Timer)



In the Mode Selection screen, navigate to the Timer icon as shown to the left and press the knob button to confirm the selection.

Turn On/Off Timer

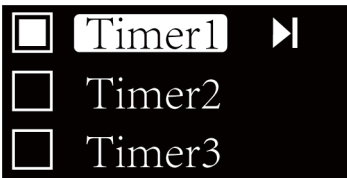

1. Highlight the word 'Timer1', 'Timer2', or 'Timer3' by turning the knob clockwise and counterclockwise.
2. Press the knob button to confirm enabling or disabling of the selected timer.

Note: Rotate the knob clockwise to go down the screen.

Edit Timer



To edit settings inside each timer:

1. Highlight the arrow icon to the right of the word 'Timer1', 'Timer2', or 'Timer3'.
2. Press the knob button once to enter Timer settings

Select the day of the week:

1. Rotate the knob to choose which day of the week for this timer to be active.
2. Press the knob button once to select the day of the week.

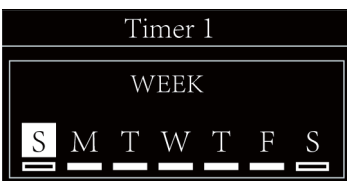

Solid bar → Day Selected.

Empty bar → Not Selected.

Note: Rotate the knob clockwise to go down the screen.

To change the Hours and Minutes under Start time and

Duration:

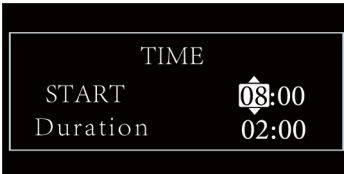
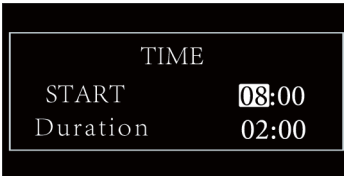

4. Highlight the Hour/Minute you'd like to modify.
5. Press the knob button once to select the hour/minute
6. Once you see up and down arrows on the hour/minute you've selected, rotate the knob to change values.
7. Duration needs to be at least 10 minutes
Hour: 0—23 hours
Minute: 0—59 minutes

Note: Rotate the knob clockwise to go down the screen.

To change the Power Intensity/Temperature/Fan speed under

Variable Heat/Thermostat/Ventilation modes:

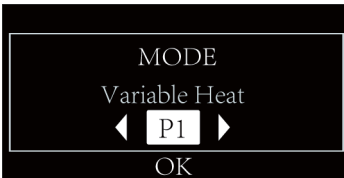

1. Highlight the value below the mode name.
2. Press the knob button once to edit value.
3. Rotate the knob clockwise or counterclockwise to change value.
4. Press the knob button once to confirm your change.

Rotate the knob clockwise to select 'OK' and press the knob button to finish editing this timer.

Settings

Press the “Settings” icon to enter the Settings menu. Turn the knob to select different sub-settings.

Press the knob to enter the sub-setting menu.

Current Time Setting



Time Setting allows the user to set the current time and date.

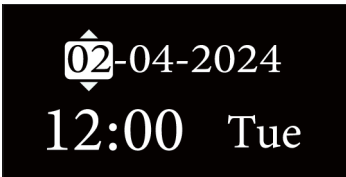
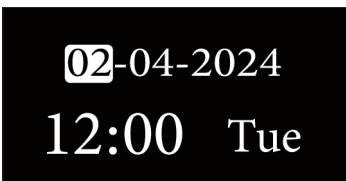

Date Format: Day-Month-Year

Time Format: 24-hour

To change values:

1. Highlight the value you'd like to modify.
2. Press the knob button once to enter edit mode.
3. Rotate the knob to change to your desired value.
4. Press the knob button once to confirm your selection.

Note: Rotate the knob clockwise to go down the screen.

Language Setting



Language Setting allows the user to change the language of the controller between Chinese and English.

Use the knob to select your language and press the knob to confirm selection.



Bluetooth Setting

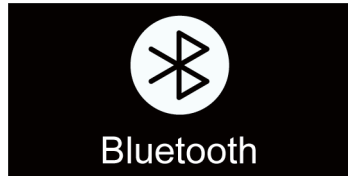

Bluetooth Setting enables or disables the Bluetooth function on the controller.

Use the knob to select ON or OFF and press the knob to confirm selection.

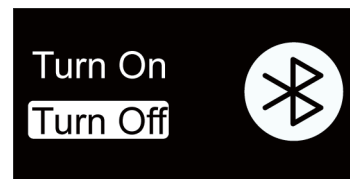
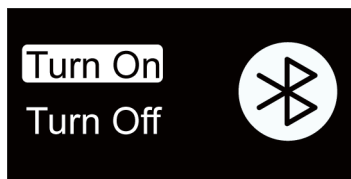

Sound Setting

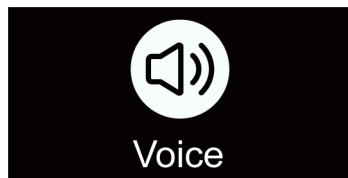

Sound Setting controls the beeping sound of the controller.

Use the knob to select ON or OFF and press the knob to confirm selection.

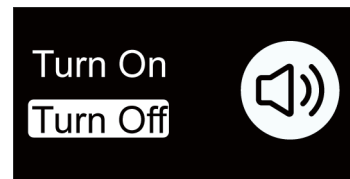
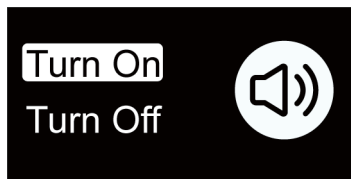

Heater Information



The heater information menu stores the heater ECU Software Version, Controller Software Version, Atmospheric Pressure and Ambient Temperature, Heater Run Time and Ignition times, and Monitor Mode.

Use the knob to select a sub-menu and press the knob to confirm selection.

ECU Software Version

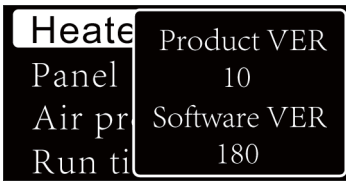

This sub-menu displays the ECU product version and the ECU software version.

This information is often used for troubleshooting and diagnostic purposes.

Controller Software Version



This sub-menu displays the Controller product version and the Controller software version.

This information is often used for troubleshooting and diagnostic purposes.

Atmospheric Pressure & Ambient Temperature

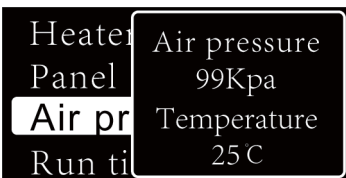

This sub-menu displays the atmospheric pressure and the ambient temperature of where the Controller is located.

Heater Run Time

Heater	Run time
Panel	40h 20m
Air pr	Ignition times
Run t	110

This sub-menu displays the Heater Run Time and the Ignition times of the heater.

Heater Run Time is used for warranty purposes.

Ignition times is how many times has the glow pin turned on, and how many times has the heater entered ignition phase.

If Heater Run Time is low and Ignition times is high, most likely the heater experienced short cycling.

Fuel Priming Function

To access the Fuel Priming Function,

1. Navigate to the [Heater Run Time](#) screen that is under “Settings” -> “Information” -> “Heater Run Time”.
2. Hold down the <Back> button and the <Settings> Button until you see the following screen.



Press the Knob once to activate Fuel Priming Function.

Fuel Priming Function will activate the fuel pump for 90 seconds, sucking and pumping fuel into the fuel lines on either side of the fuel pump. It should also eliminate as many air bubbles in the fuel line as possible.

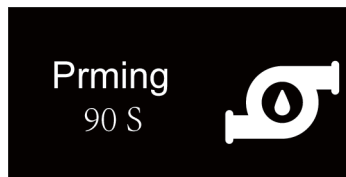

Once activated you will see a countdown of 90 seconds on the display. Once the countdown of 90 seconds finishes, the fuel pump will stop pumping.

You can exit the Fuel Priming Function before the end of the 90 seconds by pressing once on the Back Button.

You may need to activate the fuel priming function more than once if you have a long fuel line installed.

Troubleshooting



If you see “Disconnect” on the display, it means the Controller has been disconnected from the heater.

Troubleshooting Steps:

1. Try unplugging and re-plugging the Controller Cable to remedy this issue.
2. Replace the Controller Cable.
3. Replace the Controller



When a fault displays on the screen, please refer to the [Fault Code Table](#) for more details in resolving the fault.

Press and hold the knob for 2 seconds to exit the fault screen.



*Note: After dismissing the fault screen, only proceed to restart the heater after it has completely shut off.